

# Ceramic Filters (CERAFIL<sup>®</sup>)/Ceramic Discriminators for Communications Equipment



## CERAFIL<sup>®</sup> Plastic Case General Use CFULA\_A Series

CFULA\_A series are high selectivity ceramic filters, which consist of 4 ceramic elements connected in a ladder form. Most suitable for digital communications and cellular phones because of their improved GDT characteristics.

### ■ Features

1. High selectivity.
2. A variety of bandwidth available.
3. Excellent GDT characteristics are available within pass bandwidth.
4. Easily mounted on a printed circuit board
5. Operating temperature range : -20 to +80 (degree C)  
Storage temperature range : -40 to +85 (degree C)

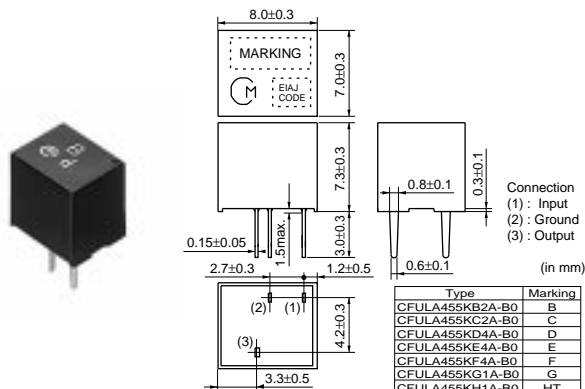

Part Number	Center Frequency (fo) (kHz)	6dB Bandwidth (kHz)	Stop Bandwidth (kHz)	Stop Band Attenuation (dB)	Insertion Loss (dB)	Input/Output Impedance (ohm)
<b>CFULA455KB2A-B0</b>	455.0 ±2.0kHz	fn±15.0 min.	fn±30.0 max. [within 40dB]	27 min. [within fn±100kHz]	4.0 max. [at minimum loss point]	1500
<b>CFULA455KC2A-B0</b>	455.0 ±2.0kHz	fn±12.5 min.	fn±24.0 max. [within 40dB]	27 min. [within fn±100kHz]	4.0 max. [at minimum loss point]	1500
<b>CFULA455KD4A-B0</b>	455.0 ±1.5kHz	fn±10.0 min.	fn±20.0 max. [within 40dB]	27 min. [within fn±100kHz]	4.0 max. [at minimum loss point]	1500
<b>CFULA455KE4A-B0</b>	455.0 ±1.5kHz	fn±7.5 min.	fn±15.0 max. [within 40dB]	27 min. [within fn±100kHz]	6.0 max. [at minimum loss point]	1500
<b>CFULA455KF4A-B0</b>	455.0 ±1.5kHz	fn±6.0 min.	fn±12.5 max. [within 40dB]	27 min. [within fn±100kHz]	6.0 max. [at minimum loss point]	2000
<b>CFULA455KG1A-B0</b>	455.0 ±1.0kHz	fn±4.5 min.	fn±10.0 max. [within 40dB]	25 min. [within fn±100kHz]	6.0 max. [at minimum loss point]	2000
<b>CFULA455KH1A-B0</b>	455.0 ±1.0kHz	fn±3.0 min.	fn±9.0 max. [within 40dB]	35 min. [within fn±100kHz]	6.0 max. [at minimum loss point]	2000

For safety purposes, connect the output of filters to the IF amplifier through a D.C. blocking capacitor. Avoid applying a direct current to the output of ceramic filters.

(fn) means nominal center frequency 455kHz.

The order quantity should be an integral multiple of the "Minimum Quantity" shown in package page in this catalog.

### ■ Test Circuit

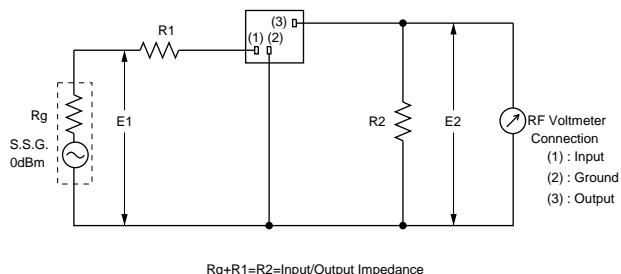

## ■ Frequency Characteristics

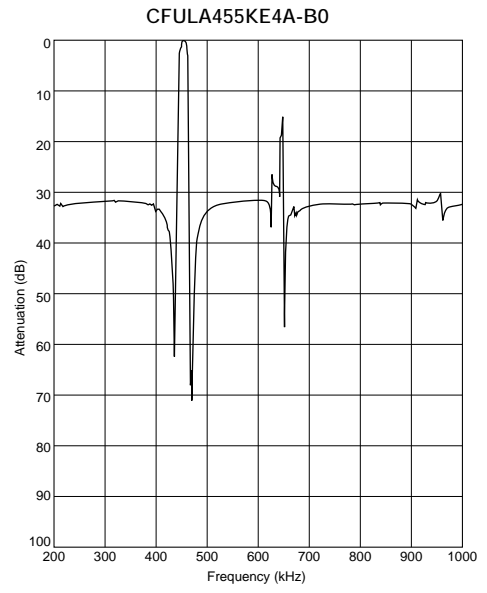
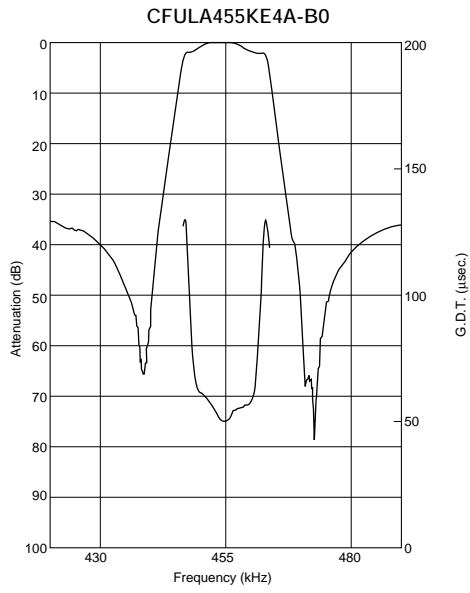

# Ceramic Filters (CERAFIL®)/Ceramic Discriminators for Communications Equipment



## CERAFIL® Plastic Case Miniaturized Type CFWLA\_A Series

Ceramic filter CFWLA\_A series are low profile high selectivity ceramic filters which use 6 elements in ladder form.

They are best suitable to high-class transceivers, cordless telephones and amateur radios.

### ■ Features

1. Low profile, high selectivity.
2. Available bandwidths are B to J as standard.
3. Easily mountable on any PC board.
4. Operating temperature range : -20 to +80 (degree C)  
Storage temperature range : -40 to +85 (degree C)

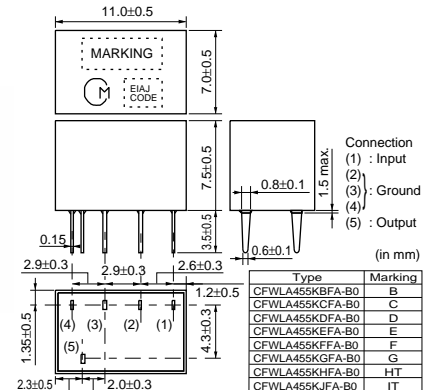

Part Number	Nominal Center Frequency (fn) (kHz)	6dB Bandwidth (kHz)	Stop Bandwidth (kHz)	Stop Band Attenuation (dB)	Insertion Loss (dB)	Ripple (dB)	Input/Output Impedance (ohm)
<b>CFWLA455KBFA-B0</b>	455	fn±15.0 min.	fn±30.0 max. [within 50dB]	35 min. [within fn±100kHz]	4.0 max. [at minimum loss point]	3.0 max. [within fn±10kHz]	1500
<b>CFWLA455KCFA-B0</b>	455	fn±12.5 min.	fn±24.0 max. [within 50dB]	35 min. [within fn±100kHz]	4.0 max. [at minimum loss point]	3.0 max. [within fn±8kHz]	1500
<b>CFWLA455KDFA-B0</b>	455	fn±10.0 min.	fn±20.0 max. [within 50dB]	35 min. [within fn±100kHz]	4.0 max. [at minimum loss point]	3.0 max. [within fn±7kHz]	1500
<b>CFWLA455KEFA-B0</b>	455	fn±7.5 min.	fn±15.0 max. [within 50dB]	35 min. [within fn±100kHz]	6.0 max. [at minimum loss point]	3.0 max. [within fn±5kHz]	1500
<b>CFWLA455KFFA-B0</b>	455	fn±6.0 min.	fn±12.5 max. [within 50dB]	35 min. [within fn±100kHz]	6.0 max. [at minimum loss point]	3.0 max. [within fn±4kHz]	2000
<b>CFWLA455KGFA-B0</b>	455	fn±4.5 min.	fn±10.0 max. [within 50dB]	35 min. [within fn±100kHz]	6.0 max. [at minimum loss point]	2.0 max. [within fn±3kHz]	2000
<b>CFWLA455KHFA-B0</b>	455	fn±3.0 min.	fn±9.0 max. [within 50dB]	60 min. [within fn±100kHz]	6.0 max. [at minimum loss point]	2.0 max. [within fn±2kHz]	2000
<b>CFWLA455KJFA-B0</b>	455	fn±2.0 min.	fn±7.5 max. [within 50dB]	60 min. [within fn±100kHz]	7.0 max. [at minimum loss point]	2.0 max. [within fn±1.5kHz]	2000

For safety purposes, connect the output of filters to the IF amplifier through a D.C. blocking capacitor. Avoid applying a direct current to the output of ceramic filters. The order quantity should be an integral multiple of the "Minimum Quantity" shown in package page in this catalog.

### ■ Test Circuit

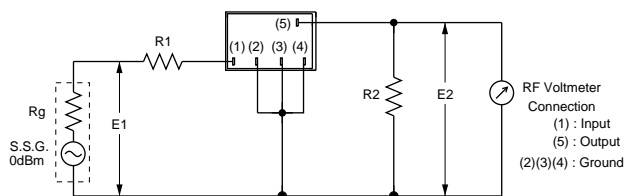

Rg+R1=R2=Input/Output Impedance

## ■ Frequency Characteristics

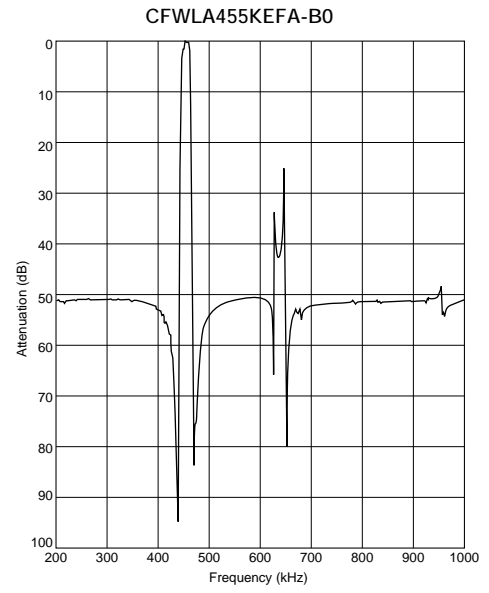
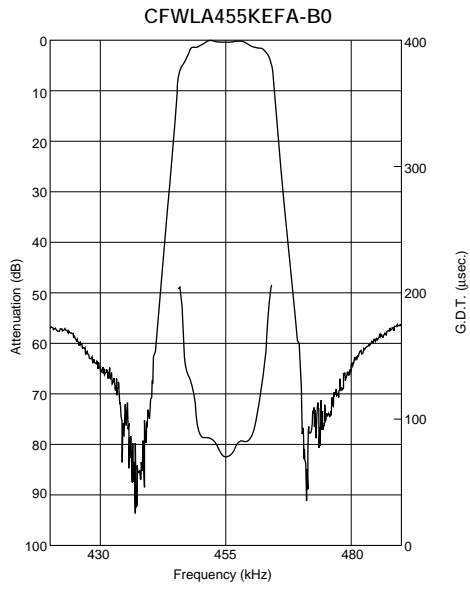

# Ceramic Filters (CERAFIL®)/Ceramic Discriminators for Communications Equipment



## CERAFIL® Plastic Case Miniaturized Type CFULB\_A Series

CFULB\_A series ceramic filters are miniature, high performance ceramic filters composed of piezoelectric elements connected in a ladder form.

These filters, with only 6.3mm high, are 65% the volume of conventional types. (CFULA455K\_A series)

They are well suited for miniaturizing various kinds of communications equipment, pocket pagers, car radios, cordless telephones and mobile telephones.

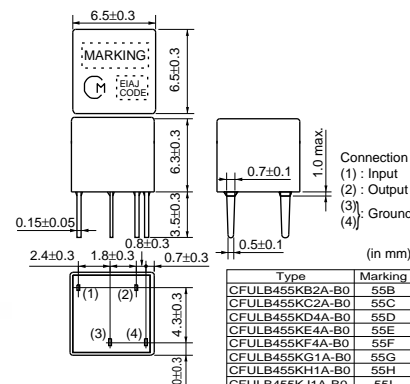

### ■ Features

1. Miniature and high selectivity.
2. A variety of bandwidths are available.
3. Operating temperature range : -20 to +80 (degree C)  
Storage temperature range : -40 to +85 (degree C)

Part Number	Center Frequency (fo) (kHz)	6dB Bandwidth (kHz)	Stop Bandwidth (kHz)	Stop Band Attenuation (dB)	Insertion Loss (dB)	Input/Output Impedance (ohm)
<b>CFULB455KB2A-B0</b>	455.0 ±2.0kHz	fn±15.0 min.	fn±30.0 max. [within 40dB]	27 min. [within fn±100kHz]	4.0 max. [at minimum loss point]	1500
<b>CFULB455KC2A-B0</b>	455.0 ±2.0kHz	fn±12.5 min.	fn±24.0 max. [within 40dB]	27 min. [within fn±100kHz]	4.0 max. [at minimum loss point]	1500
<b>CFULB455KD4A-B0</b>	455.0 ±1.5kHz	fn±10.0 min.	fn±20.0 max. [within 40dB]	27 min. [within fn±100kHz]	4.0 max. [at minimum loss point]	1500
<b>CFULB455KE4A-B0</b>	455.0 ±1.5kHz	fn±7.5 min.	fn±15.0 max. [within 40dB]	27 min. [within fn±100kHz]	6.0 max. [at minimum loss point]	1500
<b>CFULB455KF4A-B0</b>	455.0 ±1.5kHz	fn±6.0 min.	fn±12.5 max. [within 40dB]	27 min. [within fn±100kHz]	6.0 max. [at minimum loss point]	2000
<b>CFULB455KG1A-B0</b>	455.0 ±1.0kHz	fn±4.5 min.	fn±10.0 max. [within 40dB]	25 min. [within fn±100kHz]	6.0 max. [at minimum loss point]	2000
<b>CFULB455KH1A-B0</b>	455.0 ±1.0kHz	fn±3.0 min.	fn±9.0 max. [within 40dB]	35 min. [within fn±100kHz]	6.0 max. [at minimum loss point]	2000
<b>CFULB455KJ1A-B0</b>	455.0 ±1.0kHz	fn±2.0 min.	fn±7.5 max. [within 40dB]	35 min. [within fn±100kHz]	6.0 max. [at minimum loss point]	2000

For safety purposes, connect the output of filters to the IF amplifier through a D.C. blocking capacitor. Avoid applying a direct current to the output of ceramic filters.  
(fn) means nominal center frequency 455kHz.

The order quantity should be an integral multiple of the "Minimum Quantity" shown in package page in this catalog.

### ■ Test Circuit

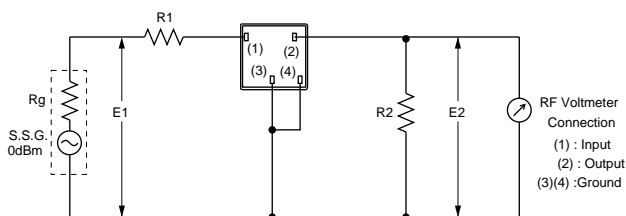

$R_g + R_1 = R_2 = \text{Input/Output Impedance}$

## ■ Frequency Characteristics

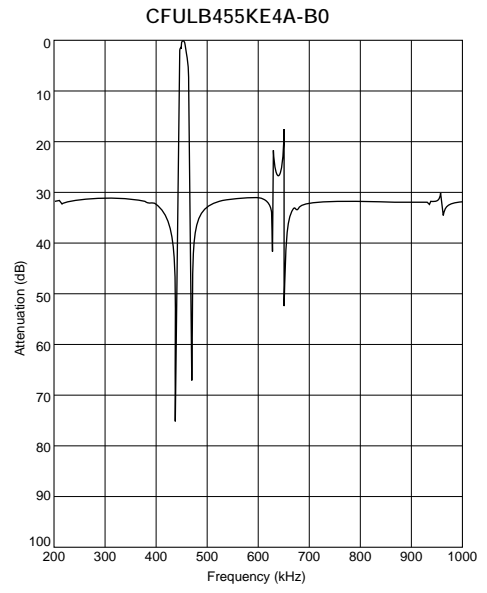
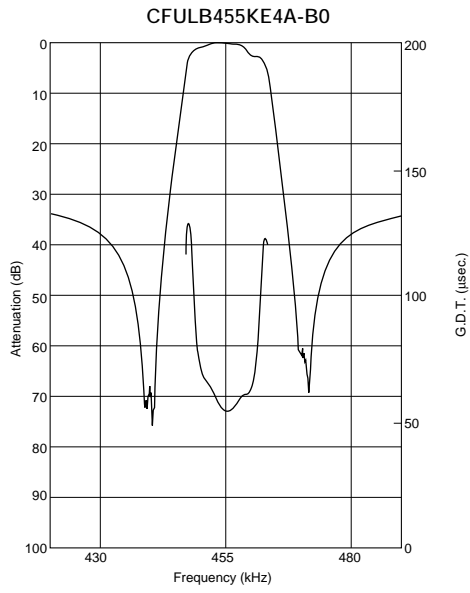

# Ceramic Filters (CERAFIL<sup>®</sup>)/Ceramic Discriminators for Communications Equipment



## CERAFIL<sup>®</sup> Plastic Case General Use CFWLB\_A Series

CFWLB\_A series ceramic filters are miniature, high performance ceramic filters composed of piezoelectric elements connected in a ladder form.

These filters, with only 6.3mm high, are 67% the volume of conventional types. (CFWLB\_A series)

They are well suited for miniaturizing various kinds of communications equipment, pocket pagers, pagers, car radios, cordless telephones and mobile telephones.

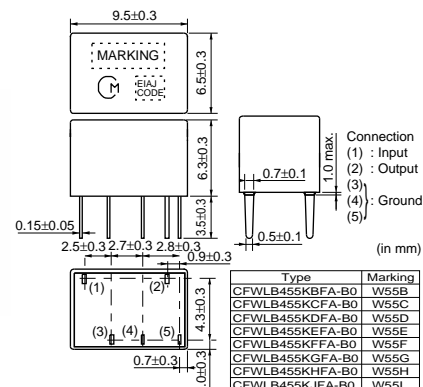

### ■ Features

1. Miniature and high selectivity.
2. A variety of bandwidths are available.
3. Operating temperature range : -20 to +80 (degree C)  
Storage temperature range : -40 to +85 (degree C)

Part Number	Nominal Center Frequency (fn) (kHz)	6dB Bandwidth (kHz)	Stop Bandwidth (kHz)	Stop Band Attenuation (dB)	Insertion Loss (dB)	Input/Output Impedance (ohm)
<b>CFWLB455KBFA-B0</b>	455	fn±15.0 min.	fn±30.0 max. [within 50dB]	35 min. [within fn±100kHz]	4.0 max. [at minimum loss point]	1500
<b>CFWLB455KCFA-B0</b>	455	fn±12.5 min.	fn±24.0 max. [within 50dB]	35 min. [within fn±100kHz]	4.0 max. [at minimum loss point]	1500
<b>CFWLB455KDFA-B0</b>	455	fn±10.0 min.	fn±20.0 max. [within 50dB]	35 min. [within fn±100kHz]	4.0 max. [at minimum loss point]	1500
<b>CFWLB455KEFA-B0</b>	455	fn±7.5 min.	fn±15.0 max. [within 50dB]	35 min. [within fn±100kHz]	6.0 max. [at minimum loss point]	1500
<b>CFWLB455KEFA004-B0</b>	455	fn±7.5 min.	fn±15.0 max. [within 60dB]	60 min. [within fn±15kHz to 30kHz]	5.0 max. [at fn]	1500
<b>CFWLB455KFFA-B0</b>	455	fn±6.0 min.	fn±12.5 max. [within 50dB]	35 min. [within fn±100kHz]	6.0 max. [at minimum loss point]	2000
<b>CFWLB455KGFA-B0</b>	455	fn±4.5 min.	fn±10.0 max. [within 50dB]	35 min. [within fn±100kHz]	6.0 max. [at minimum loss point]	2000
<b>CFWLB455KHFA-B0</b>	455	fn±3.0 min.	fn±9.0 max. [within 50dB]	55 min. [within fn±100kHz]	6.0 max. [at minimum loss point]	2000
<b>CFWLB455KJFA-B0</b>	455	fn±2.0 min.	fn±7.0 max. [within 50dB]	55 min. [within fn±100kHz]	7.0 max. [at minimum loss point]	2000

For safety purposes, connect the output of filters to the IF amplifier through a D.C. blocking capacitor. Avoid applying a direct current to the output of ceramic filters. The order quantity should be an integral multiple of the "Minimum Quantity" shown in package page in this catalog.

### ■ Test Circuit

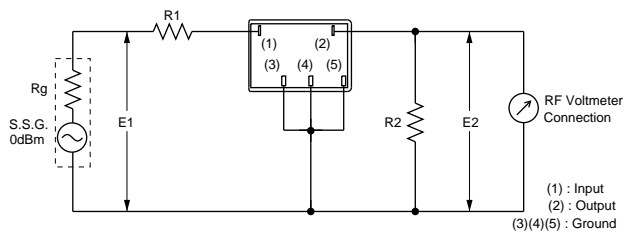

$R_g + R_1 = R_2 = \text{Input/Output Impedance}$

### ■ Frequency Characteristics

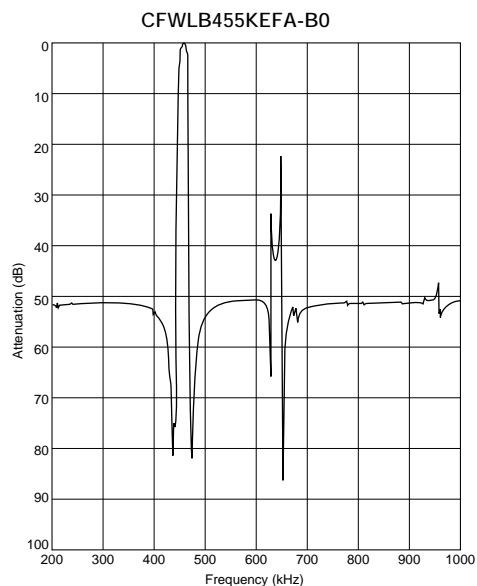
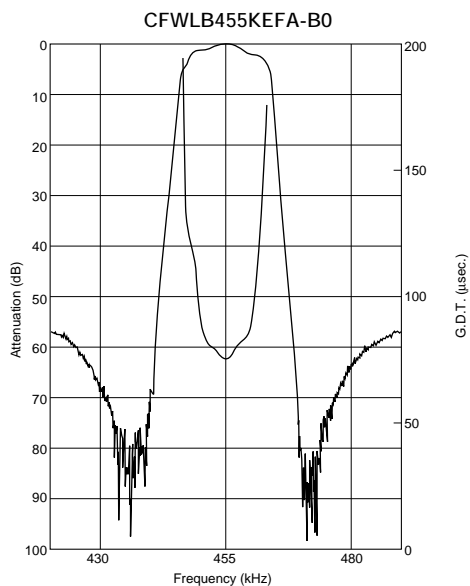



# Ceramic Filters (CERAFIL®)/Ceramic Discriminators for Communications Equipment



## CERAFIL® Plastic Case Group Delay Flat Type CFULA\_Y Series

CFULA\_Y series are high selectivity ceramic filters, which consist of 4 ceramic elements connected in a ladder form. Most suitable for digital communications and cellular phones because of their improved GDT characteristics.

### ■ Features

1. High selectivity.
2. A variety of bandwidth available.
3. Excellent GDT characteristics are available within pass bandwidth.
4. Easily mounted on a printed circuit board
5. Operating temperature range : -20 to +80 (degree C)  
Storage temperature range : -40 to +85 (degree C)

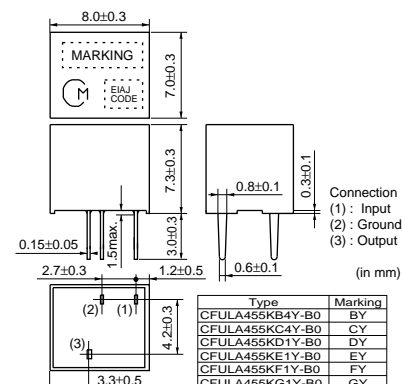

Part Number	Center Frequency (fo) (kHz)	6dB Bandwidth (kHz)	Stop Bandwidth (kHz)	Stop Band Attenuation (dB)	Insertion Loss (dB)	GDT Deviation (μs)	Input/Output Impedance (ohm)
<b>CFULA455KB4Y-B0</b>	455.0 ±1.5kHz	fn±15.0 min.	fn±35.0 max. [within 40dB]	25 min. [within fn±100kHz]	5.0 max. [at minimum loss point]	15.0 max. [within fn±10kHz]	1500
<b>CFULA455KC4Y-B0</b>	455.0 ±1.5kHz	fn±12.5 min.	fn±30.0 max. [within 40dB]	25 min. [within fn±100kHz]	6.0 max. [at minimum loss point]	15.0 max. [within fn±8kHz]	1500
<b>CFULA455KD1Y-B0</b>	455.0 ±1.0kHz	fn±10.0 min.	fn±25.0 max. [within 40dB]	23 min. [within fn±100kHz]	7.0 max. [at minimum loss point]	20.0 max. [within fn±7kHz]	1500
<b>CFULA455KE1Y-B0</b>	455.0 ±1.0kHz	fn±7.5 min.	fn±20.0 max. [within 40dB]	23 min. [within fn±100kHz]	8.0 max. [at minimum loss point]	20.0 max. [within fn±5kHz]	1500
<b>CFULA455KF1Y-B0</b>	455.0 ±1.0kHz	fn±6.0 min.	fn±17.5 max. [within 40dB]	23 min. [within fn±100kHz]	9.0 max. [at minimum loss point]	20.0 max. [within fn±4kHz]	2000
<b>CFULA455KG1Y-B0</b>	455.0 ±1.0kHz	fn±4.5 min.	fn±15.0 max. [within 40dB]	23 min. [within fn±100kHz]	10.0 max. [at minimum loss point]	20.0 max. [within fn±3kHz]	2000

For safety purposes, connect the output of filters to the IF amplifier through a D.C. blocking capacitor. Avoid applying a direct current to the output of ceramic filters.

(fn) means nominal center frequency 455kHz.

The order quantity should be an integral multiple of the "Minimum Quantity" shown in package page in this catalog.

### ■ Test Circuit

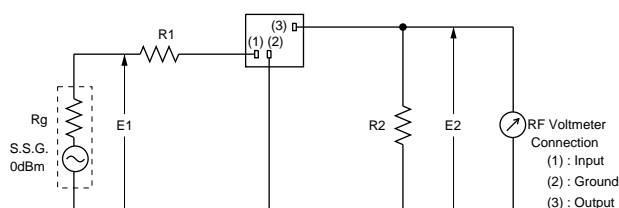

$$R_g + R_1 = R_2 = \text{Input/Output Impedance}$$

## ■ Frequency Characteristics

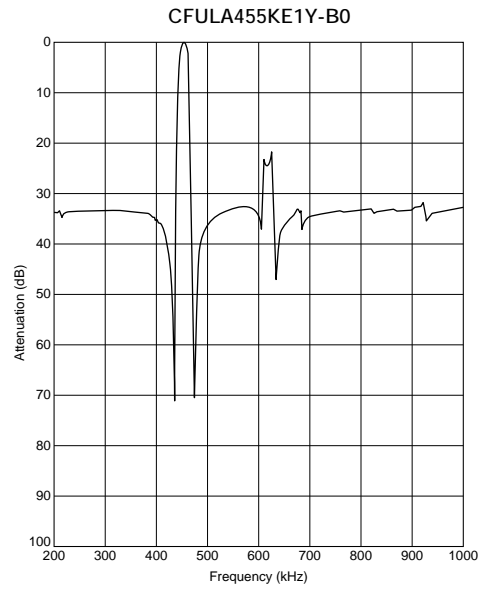
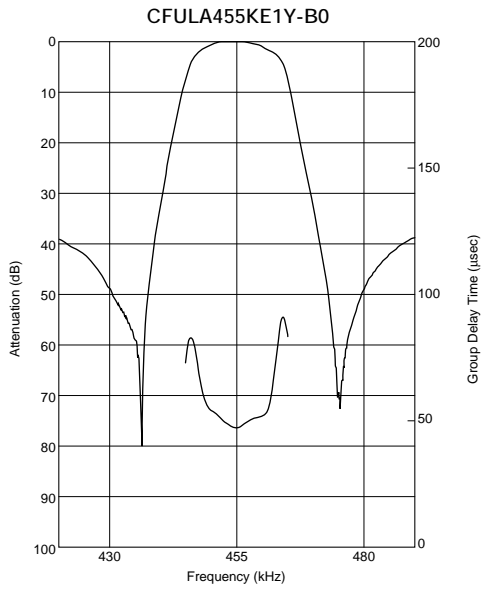

# Ceramic Filters (CERAFIL®)/Ceramic Discriminators for Communications Equipment



## CERAFIL® Plastic Case Group Delay Flat Type CFWLA\_Y Series

CFWLA\_Y series are high selectivity ceramic filters, which consist of 6 ceramic elements connected in a ladder form.

Most suitable for digital communications and mobile telephones because of their improved GDT characteristics.

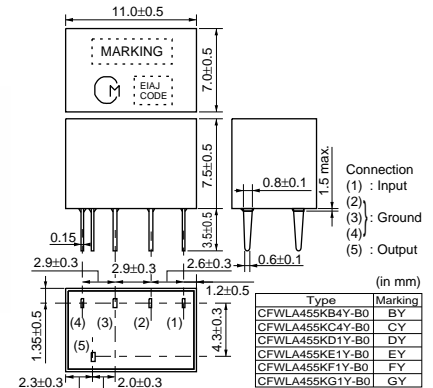

### ■ Features

1. High selectivity.
2. A variety of bandwidths are available.
3. Excellent GDT characteristics are available within pass bandwidth.
4. Easily mounted on a printed circuit board
5. Operating temperature range : -20 to +80 (degree C)  
Storage temperature range : -40 to +85 (degree C)

Part Number	Center Frequency (fo) (kHz)	6dB Bandwidth (kHz)	Stop Bandwidth (kHz)	Stop Band Attenuation (dB)	Insertion Loss (dB)	GDT Deviation (μs)	Input/Output Impedance (ohm)
<b>CFWLA455KB4Y-B0</b>	455.0 ±1.5kHz	fn±15.0 min.	fn±35.0 max. [within 50dB]	40 min. [within fn±100kHz]	6.0 max. [at minimum loss point]	30.0 max. [within fn±10kHz]	1500
<b>CFWLA455KC4Y-B0</b>	455.0 ±1.5kHz	fn±12.5 min.	fn±30.0 max. [within 50dB]	40 min. [within fn±100kHz]	7.0 max. [at minimum loss point]	30.0 max. [within fn±8kHz]	1500
<b>CFWLA455KD1Y-B0</b>	455.0 ±1.0kHz	fn±10.0 min.	fn±25.0 max. [within 50dB]	40 min. [within fn±100kHz]	8.0 max. [at minimum loss point]	30.0 max. [within fn±7kHz]	1500
<b>CFWLA455KE1Y-B0</b>	455.0 ±1.0kHz	fn±7.5 min.	fn±20.0 max. [within 50dB]	40 min. [within fn±100kHz]	9.0 max. [at minimum loss point]	30.0 max. [within fn±5kHz]	1500
<b>CFWLA455KF1Y-B0</b>	455.0 ±1.0kHz	fn±6.0 min.	fn±17.5 max. [within 50dB]	40 min. [within fn±100kHz]	10.0 max. [at minimum loss point]	40.0 max. [within fn±4kHz]	2000
<b>CFWLA455KG1Y-B0</b>	455.0 ±1.0kHz	fn±4.5 min.	fn±15.0 max. [within 50dB]	40 min. [within fn±100kHz]	11.0 max. [at minimum loss point]	40.0 max. [within fn±3kHz]	2000

For safety purposes, connect the output of filters to the IF amplifier through a D.C. blocking capacitor. Avoid applying a direct current to the output of ceramic filters.  
(fn) means nominal center frequency 455kHz.

The order quantity should be an integral multiple of the "Minimum Quantity" shown in package page in this catalog.

### ■ Test Circuit

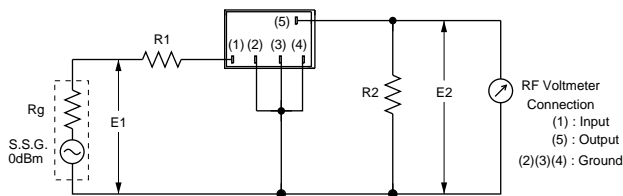

$R_g + R_1 = R_2 = \text{Input/Output Impedance}$

## ■ Frequency Characteristics

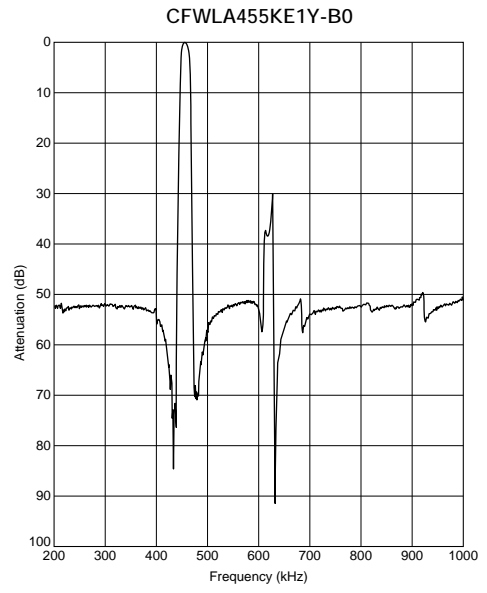
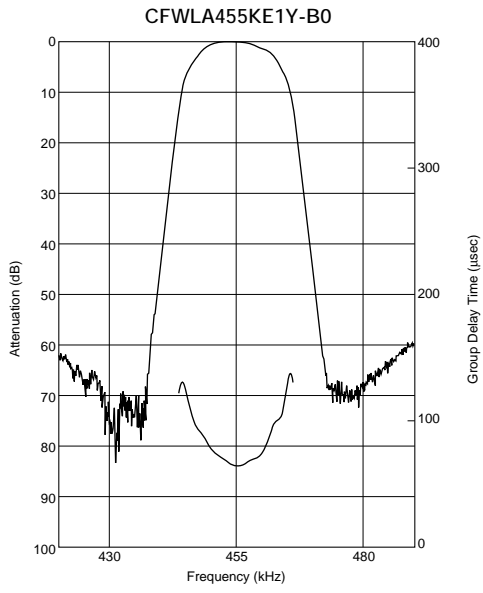

# Ceramic Filters (CERAFIL<sup>®</sup>)/Ceramic Discriminators for Communications Equipment



## CERAFIL<sup>®</sup> Plastic Case Group Delay Flat Type Miniaturized Type CFULB\_Y Series

Ceramic filter CFULB\_Y series are miniature and high performance filters. These filters, with only 6.3mm high, are 65% the volume of conventional types (CFULA455K\_Y series).

Well suited for miniaturizing the communications equipment, especially for a cellular phone.

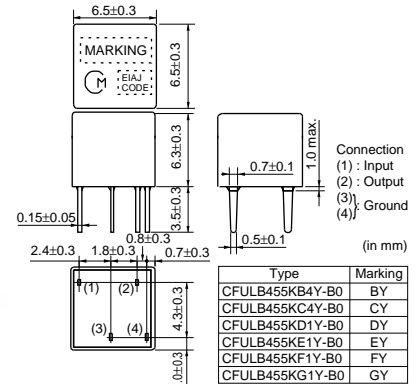

### ■ Features

1. Miniature, flat GDT characteristics.
2. Suitable for a cellular phone.
3. A variety of band width are available.
4. Operating temperature range : -20 to +80 (degree C)  
Storage temperature range : -40 to +85 (degree C)

Part Number	Center Frequency (fo) (kHz)	6dB Bandwidth (kHz)	Stop Bandwidth (kHz)	Stop Band Attenuation (dB)	Insertion Loss (dB)	GDT Deviation (μs)	Input/Output Impedance (ohm)
<b>CFULB455KB4Y-B0</b>	455.0 ±1.5kHz	fn±15.0 min.	fn±35.0 max. [within 40dB]	25 min. [within fn±100kHz]	5.0 max. [at minimum loss point]	15.0 max. [within fn±10kHz]	1500
<b>CFULB455KC4Y-B0</b>	455.0 ±1.5kHz	fn±12.5 min.	fn±30.0 max. [within 40dB]	25 min. [within fn±100kHz]	6.0 max. [at minimum loss point]	15.0 max. [within fn±8kHz]	1500
<b>CFULB455KD1Y-B0</b>	455.0 ±1.0kHz	fn±10.0 min.	fn±25.0 max. [within 40dB]	23 min. [within fn±100kHz]	7.0 max. [at minimum loss point]	20.0 max. [within fn±7kHz]	1500
<b>CFULB455KE1Y-B0</b>	455.0 ±1.0kHz	fn±7.5 min.	fn±20.0 max. [within 40dB]	23 min. [within fn±100kHz]	8.0 max. [at minimum loss point]	20.0 max. [within fn±5kHz]	1500
<b>CFULB455KF1Y-B0</b>	455.0 ±1.0kHz	fn±6.0 min.	fn±17.5 max. [within 40dB]	23 min. [within fn±100kHz]	9.0 max. [at minimum loss point]	20.0 max. [within fn±4kHz]	2000
<b>CFULB455KG1Y-B0</b>	455.0 ±1.0kHz	fn±4.5 min.	fn±15.0 max. [within 40dB]	23 min. [within fn±100kHz]	10.0 max. [at minimum loss point]	20.0 max. [within fn±3kHz]	2000

For safety purposes, connect the output of filters to the IF amplifier through a D.C. blocking capacitor. Avoid applying a direct current to the output of ceramic filters. (fn) means nominal center frequency 455kHz.

The order quantity should be an integral multiple of the "Minimum Quantity" shown in package page in this catalog. CFULB455K\_Y series filters are 4-element ceramic filters and miniature versions of CFULA455K\_Y series.

### ■ Test Circuit

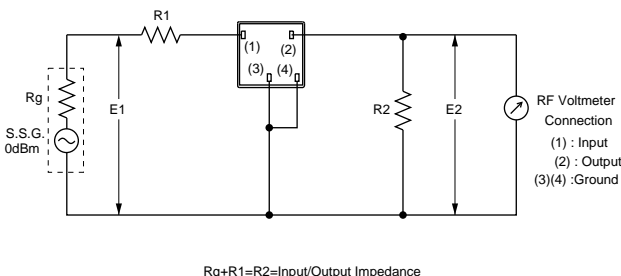

## ■ Frequency Characteristics

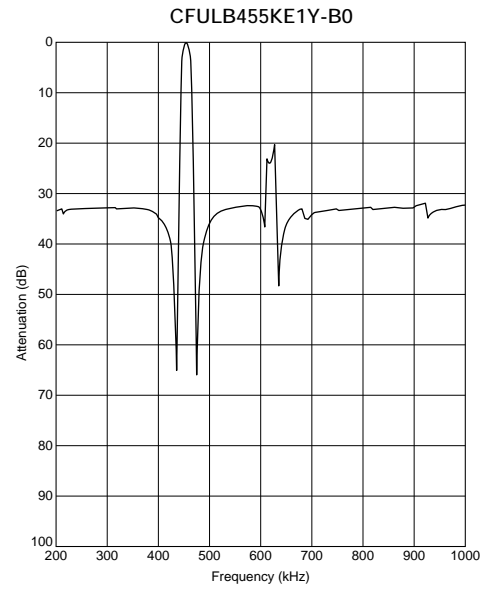
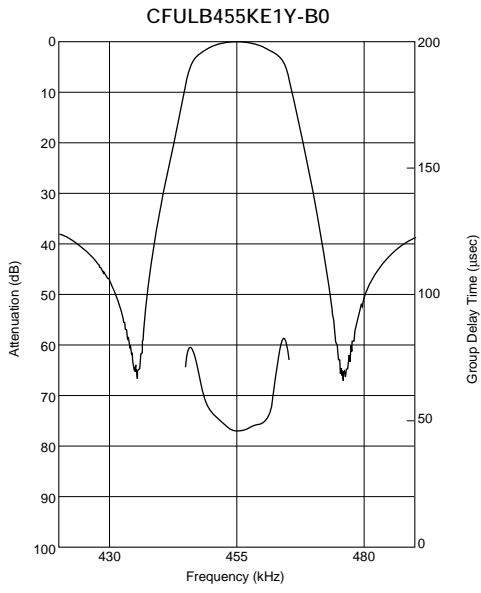

# Ceramic Filters (CERAFIL<sup>®</sup>)/Ceramic Discriminators for Communications Equipment



## CERAFIL<sup>®</sup> Plastic Case Group Delay Flat Type CFWLB\_Y Series

Ceramic filter CFWLB\_Y series are miniature and high-performance filters. These filters, with only 6.3mm high, are 67% the volume of conventional types (CFWLA455K\_Y series).

Well suited for miniaturizing the communications equipment, especially for a cellular phone.

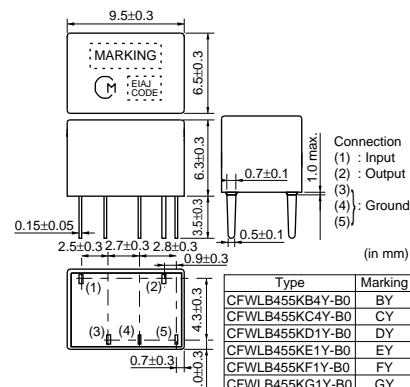

### ■ Features

1. Miniature, flat GDT characteristics.
2. Suitable for a cellular phone.
3. A variety of band width are available.
4. Operating temperature range : -20 to +80 (degree C)  
Storage temperature range : -40 to +85 (degree C)

Part Number	Center Frequency (fo) (kHz)	6dB Bandwidth (kHz)	Stop Bandwidth (kHz)	Stop Band Attenuation (dB)	Insertion Loss (dB)	GDT Deviation (μs)	Input/Output Impedance (ohm)
<b>CFWLB455KB4Y-B0</b>	455.0 ±1.5kHz	fn±15.0 min.	fn±30.0 max. [within 50dB]	40 min. [within fn±100kHz]	6.0 max. [at minimum loss point]	30.0 max. [within fn±10kHz]	1500
<b>CFWLB455KC4Y-B0</b>	455.0 ±1.5kHz	fn±12.5 min.	fn±27.5 max. [within 50dB]	40 min. [within fn±100kHz]	7.0 max. [at minimum loss point]	30.0 max. [within fn±8kHz]	1500
<b>CFWLB455KD1Y-B0</b>	455.0 ±1.0kHz	fn±10.0 min.	fn±25.0 max. [within 50dB]	40 min. [within fn±100kHz]	8.0 max. [at minimum loss point]	30.0 max. [within fn±7kHz]	1500
<b>CFWLB455KE1Y-B0</b>	455.0 ±1.0kHz	fn±7.5 min.	fn±20.0 max. [within 50dB]	40 min. [within fn±100kHz]	9.0 max. [at minimum loss point]	30.0 max. [within fn±5kHz]	1500
<b>CFWLB455KF1Y-B0</b>	455.0 ±1.0kHz	fn±6.0 min.	fn±17.5 max. [within 50dB]	40 min. [within fn±100kHz]	10.0 max. [at minimum loss point]	40.0 max. [within fn±4kHz]	2000
<b>CFWLB455KG1Y-B0</b>	455.0 ±1.0kHz	fn±4.5 min.	fn±15.0 max. [within 50dB]	40 min. [within fn±100kHz]	11.0 max. [at minimum loss point]	40.0 max. [within fn±3kHz]	2000

For safety purposes, connect the output of filters to the IF amplifier through a D.C. blocking capacitor. Avoid applying a direct current to the output of ceramic filters.  
(fn) means nominal center frequency 455kHz.

The order quantity should be an integral multiple of the "Minimum Quantity" shown in package page in this catalog.  
CFWLB455K\_Y series filters are 4-element ceramic filters and miniature versions of CFWLA455K\_Y series.

### ■ Test Circuit

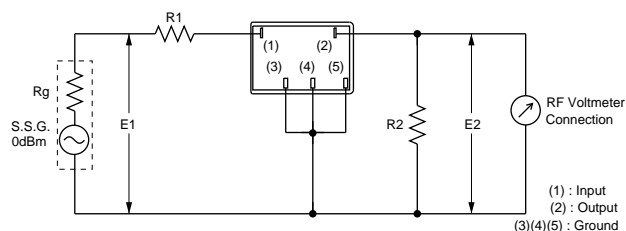

$R_g + R_1 = R_2 = \text{Input/Output Impedance}$

## ■ Frequency Characteristics

